

RS 195

Digital Wireless Headphone System



Instruction Manual

Contents

- Important safety information** 2
- The RS 195 digital wireless headphone system** 4
- Package includes** 5
- Product overview** 6
 - Overview of the HDR 195 headphones 6
 - Overview of the TR 195 transmitter 7
 - Overview of LED indicators 8
- Putting the RS 195 into operation** 11
 - Setting up the transmitter 11
 - Connecting the transmitter to an audio source 12
 - Connecting the transmitter to an AC wall outlet 16
 - Inserting or replacing the rechargeable batteries 17
 - Charging the rechargeable batteries 18
 - Adjusting the headband 19
- Using your RS 195 headphone system** 20
 - Switching your wireless headphone system on 20
 - Selecting an audio input 21
 - Adjusting the volume 21
 - Muting/unmuting the headphones 21
 - Adjusting the balance 22
 - Activating/deactivating “personal hearing” 23
 - “Personal hearing” – Selecting a hearing profile for hearing enhance-
ment 24
 - “Personal hearing” – Selecting additional sound optimization options
for speech or music listening 25
 - Pairing headphones to the transmitter 26
 - Switching your wireless headphones off 27
- Cleaning and maintaining the RS 195** 28
 - Replacing the ear pads 28
- Troubleshooting** 29
 - Sound problems 29
 - Other problems 30
 - Leaving the range of the transmitter 31
 - Clearing the pair settings on the headphones 31
- Specifications** 32
- Manufacturer declarations** 33



Important safety information

- ▶ Read this instruction manual carefully and completely before using the product.
- ▶ Always include this instruction manual when passing the product on to third parties.
- ▶ Do not use an obviously defective product.

Preventing damage to health and accidents

- ▶ Protect your hearing from high volume levels. Permanent hearing damage may occur when headphones are used at high volume levels for long periods of time. Sennheiser headphones sound exceptionally good at low and medium volume levels.
- ▶ Keep the headphones at least 10 cm/3.94" from cardiac pacemakers or implanted defibrillators. The headphones contain magnets that generate a magnetic field which could cause interference with cardiac pacemakers and implanted defibrillators.
- ▶ Keep the product, accessories and packaging parts out of reach of children and pets to prevent accidents and choking hazards.
- ▶ Do not use the product in situations which require special attention (e.g. in traffic or when performing skilled jobs).

Preventing damage to the product and malfunctions

- ▶ Always keep the product dry and do not expose it to extreme temperatures to avoid corrosion or deformation. The normal operating temperature is from 0 to 40°C/32 to 104°F.
- ▶ Use only attachments/accessories/spare parts supplied or recommended by Sennheiser.
- ▶ Unplug the power supply unit from the AC wall outlet if you are not going to use the product for extended periods of time.
- ▶ Varnish or furniture polish may degrade the feet of the transmitter, which could stain your furniture. You should therefore place the transmitter on a non-slip pad to avoid potential staining of furniture.
- ▶ Do not place your headphones on a glass dummy head, chair armrest or similar objects for long periods as this can widen the headband and reduce the contact pressure of the headphones.
- ▶ Clean the product only with a soft, dry cloth.

Intended use/Liability

This wireless headphone system is suitable for use with hi-fi systems, TV sets, and home cinema systems and supports both analog and digital signals simultaneously.

This product is intended for private domestic use only. It is not suitable for commercial use. This product is also not intended to be used with portable audio devices.

It is considered improper use when this product is used for any application not named in this instruction manual and the associated product guides.

Sennheiser does not accept liability for damage arising from abuse or misuse of this product and its attachments/accessories.

Safety instructions for standard/rechargeable batteries



WARNING

In extreme cases, the standard/rechargeable batteries may leak and may cause the following hazards if abused or misused:

- explosion
- fire
- heat
- smoke/gas

	Keep away from children.		Do not heat above 70°C/158°F, e.g. do not expose to sunlight or throw into a fire.
	Do not expose to moisture.		When not using rechargeable batteries for extended periods of time, charge them regularly (about every 3 months).
	Do not mutilate or dismantle.		When not using the product for extended periods of time, remove the standard/rechargeable batteries.
	Observe correct polarity.		Use only rechargeable batteries and chargers recommended by Sennheiser.
	Pack/store standard/charged rechargeable batteries so that the terminals cannot contact each other – danger of shorting out/ fire hazard.		Do not continue using defective standard/rechargeable batteries and dispose of them immediately
	Switch battery-powered products off after use.		Immediately remove standard/rechargeable batteries from an obviously defective product.
	Charge rechargeable batteries at ambient temperatures between 10 and 40°C/50 and 104°F.		Dispose of standard/rechargeable batteries at special collection points or return them to your specialist dealer.
	Do not charge standard batteries.		Do not mix standard and rechargeable batteries in the battery compartments.

The RS 195 digital wireless headphone system

The RS 195 is your personal hearing and ultimate audio companion, providing you with all of the unparalleled sound quality, ease of use and wearing comfort that you expect from a Sennheiser product.

Whether you are watching television or listening to music, the RS 195 ensures that you won't miss a thing: Highly innovative digital wireless technology guarantees crystal clear signal transmission with low latency even while you move from room to room, and the various listening modes allow you to adapt the sound according to your individual needs and preferences. With the RS 195 you'll be able to hear the subtle nuances of dialogues and the slight details of your favorite music like never before.

And although these headphones deliver state-of-the-art performance, their user-friendly design keeps things simple. The convenient controls make it easy to take advantage of the host of features, and the ergonomic design provides a comfortable fit, even after hours of listening.

Sennheiser's RS 195: Personal and adaptable to your listening needs!

Features

- Closed, circumaural headphones with excellent digital wireless audio transmission
- Exceptional digital audio clarity and transmission range of up to 100 m/328 ft (line of sight)
- Selectable hearing boost presets and an additional noise suppression mode for clearer dialogues and superior speech intelligibility
- Or choose the music listening mode which reproduces music with an increased dynamic range to preserve the sound image in the best possible way
- Supports analog and digital audio inputs and allows toggling between the inputs
- Multi-purpose transmitter – also functions as “easy-charge” cradle and docking station
- Balance control for right/left volume adjustment
- Ergonomic design for enhanced wearing comfort
- 2-year warranty



Package includes



HDR 195 headphones

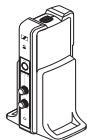

TR 195 transmitter



Power supply unit with multi-country adapters
(EU, UK, US, AU)

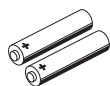

Low self-discharge NiMH rechargeable batteries, AAA size



Optical digital cable, 1.5 m



Stereo audio cable with 3.5 mm jack plugs, 2 m



Quick guide in 15 languages



Brief instruction manual in German, English and French
including CD with detailed instruction manual (PDF files)
in 15 languages



Safety guide in 15 languages

Product overview

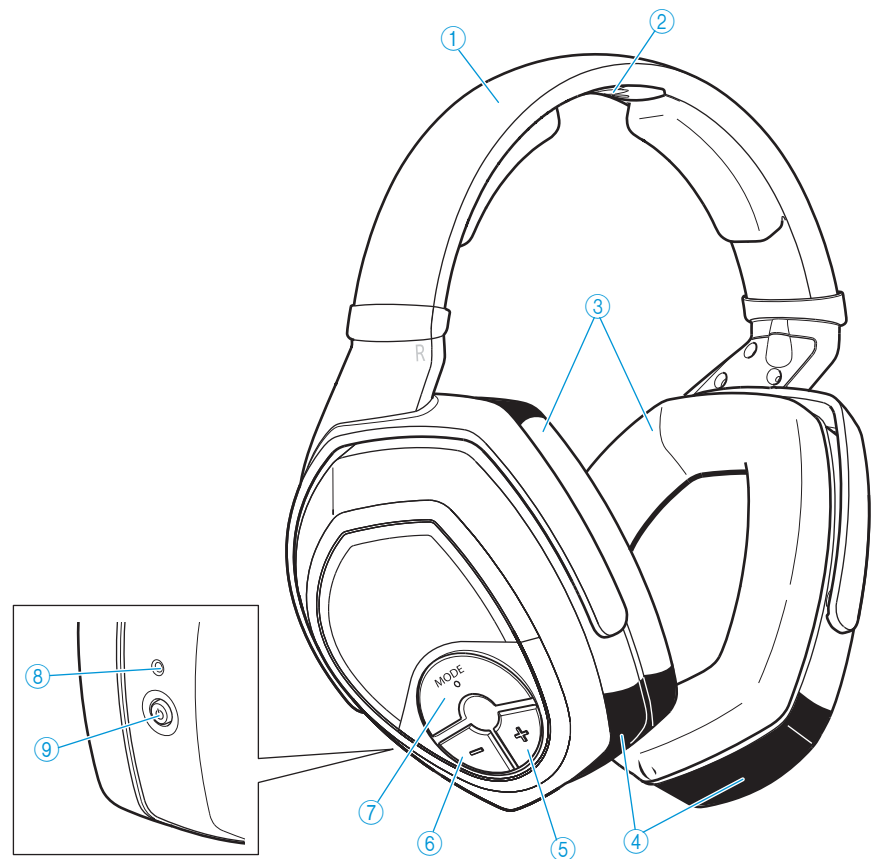

Overview of the HDR 195 headphones

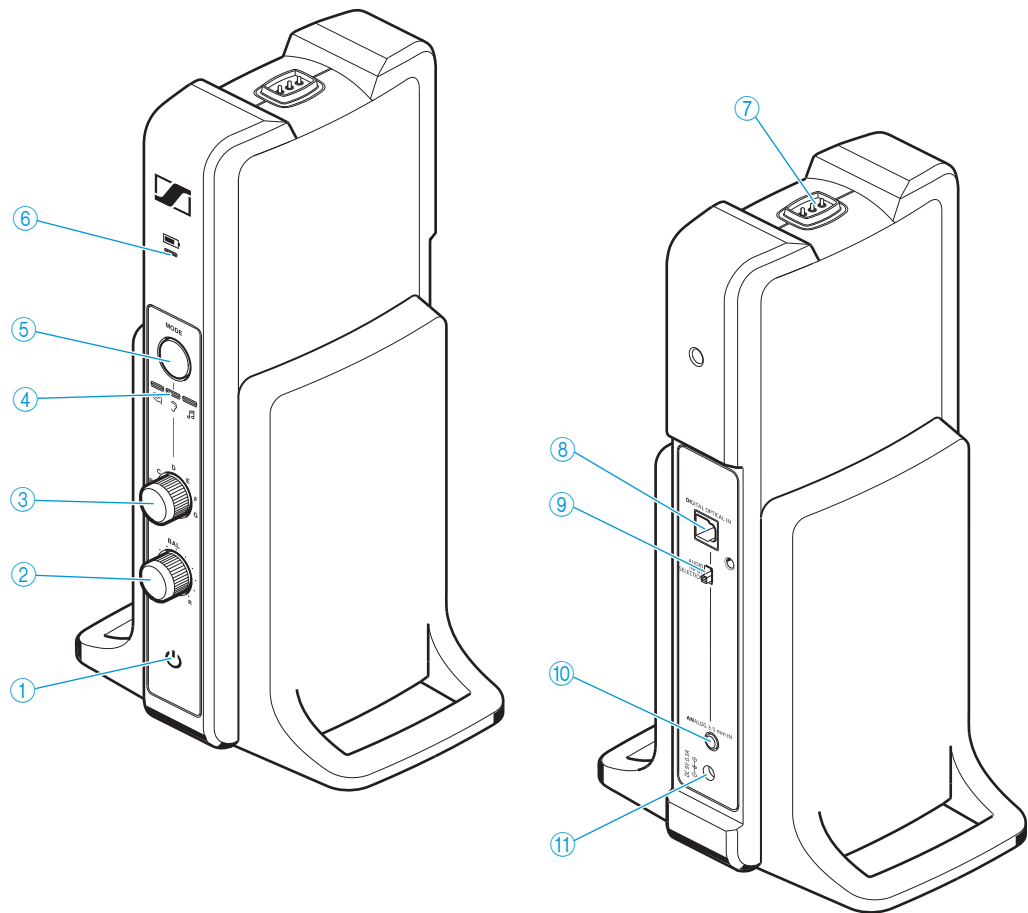

- ① Headband
- ② Charging contacts
- ③ Ear pads
- ④ Ear cups/Battery compartments
- ⑤ Volume + button
- ⑥ Volume - button
- ⑦ **MODE** button for personal hearing
- ⑧ HDR status LED
- ⑨ HDR power button 

Overview of the TR 195 transmitter



- ① TR status LED 
- ② BAL control for adjusting the balance
- ③ A-G rotary switch for selecting the hearing profile
- ④ LEDs for personal hearing, indicating the selected sound optimization
- ⑤ MODE button for personal hearing
- ⑥ Charge status LED 
- ⑦ Charging contacts
- ⑧ DIGITAL OPTICAL IN Digital optical audio input
- ⑨ AUDIO INPUT SELECTION switch, for digital or analog audio input selection
- ⑩ ANALOG 3.5 mm IN analog audio input (3.5 mm jack)
- ⑪ DC 9V 0.3A socket for the power supply unit

Overview of LED indicators

The LED indicators on the headphones and on the transmitter indicate the current operating state. If you are not using the headphones, the LED indicators automatically dim after approx. 30 seconds to not disturb you.

LED indicators on the headphones

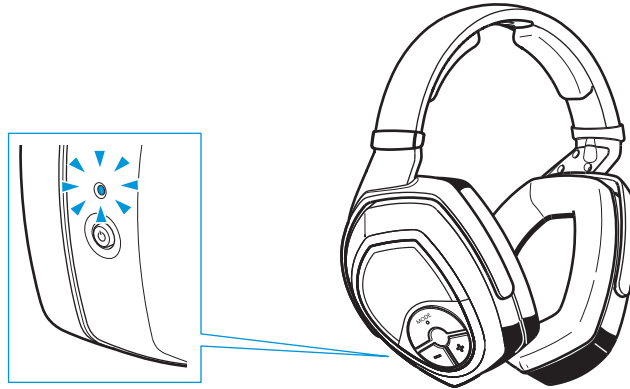

HDR status LED	Meaning
	The headphones are switched off.
	The transmitter and headphones are connected.
	The transmitter and headphones are connected and the rechargeable batteries are almost empty.
	The headphones are disconnected from or cannot connect to the transmitter.
	The headphones are disconnected from or cannot connect to the transmitter and the rechargeable batteries are almost empty.

LED indicators on the transmitter

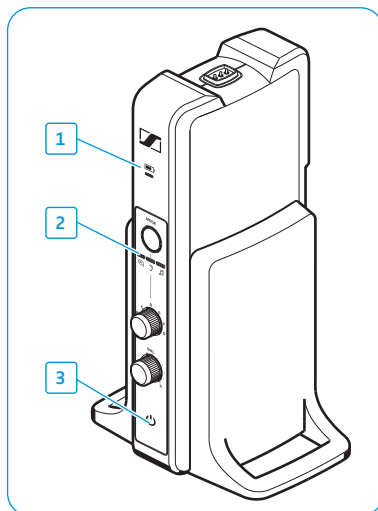



1	Charge status LED	Meaning
		The transmitter is not charging.
		The rechargeable batteries are being charged.
		The rechargeable batteries are fully charged.
		A charging/battery fault has been detected.

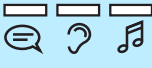

After taking the headphones from the holder of the transmitter, the charge status LED indicates the approximate operating time of the headphones:

Charge status LED	Operating time	Battery capacity
	up to 4 hours	0-25%
	approx. 4 to 9 hours	25-50%
	approx. 9 to 14 hours	50-75%
	approx. 14 to 18 hours	75-100%

2	Personal hearing LED	Meaning
		One of the hearing profiles A-G for hearing enhancement is selected.
		In addition to the selected hearing profile, speech intelligibility is improved as annoying noise is reduced.
		The selected hearing profile reproduces music with an increased dynamic to preserve the sound image in the best possible way.

Personal hearing LED	Meaning
	Personal hearing is switched off and the selected hearing profile is deactivated; the sound from the audio source is reproduced unchanged (normal hearing).
	If all three LEDs flash three times, more than one pair of headphones is connected to the transmitter. Switch off the other headphones in order to activate personal hearing.

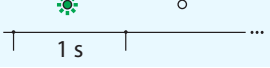
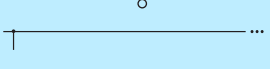
3

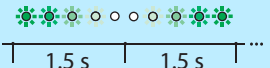
TR status LED 	Meaning
	The transmitter is connected to the AC wall outlet.
	The transmitter is in standby mode.
	The transmitter and headphones are connected.
	The transmitter detects an incompatible digital audio streaming input (see page 29).

Putting the RS 195 into operation

Setting up the transmitter

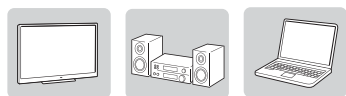

- ▶ Choose a suitable place near your audio source.
- ▶ Separate the transmitter from other wireless devices in the room by at least 50 cm/20" to avoid interference.
- ▶ Do not place the transmitter close to metal objects such as shelf bars, reinforced concrete walls, etc. as this can decrease the transmission range of the transmitter.

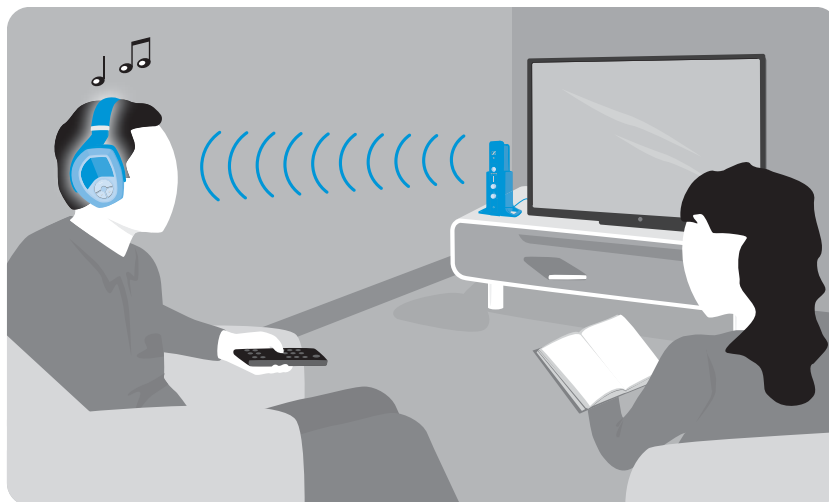

Connecting the transmitter to an audio source

You can simultaneously connect 2 different audio sources (e.g. a TV and a stereo hi-fi system) to the transmitter. The transmitter features a digital as well as an analog audio input. If you connect 2 audio sources, you can toggle between them using the **AUDIO INPUT SELECTION** switch (see page 21).

i You can also refer to the beginner's video guides on how to connect your digital wireless headphone system to a TV at www.sennheiser.com/how-to-videos.

- ▶ Switch your audio source off before connecting the transmitter.
- ▶ Check the connection options available for your audio source (audio output, usually marked "OUT").
- ▶ Select the corresponding connection cable and, if necessary, a suitable adapter.
- ▶ Depending on the connection option selected, go to the respective chapter and follow the instructions on how to connect the transmitter to an audio source.

Connection options available for your audio source	Connection cable	Page
A Optical (digital)	Optical digital cable	13
B 3.5 mm or 6.3 mm/ 1/4" jack socket (analog)	Stereo audio cable; in case of a 6.3 mm/ 1/4" jack socket: with adapter 3.5 mm jack socket to 6.3 mm/ 1/4" jack plug (to be ordered separately)	14
C RCA (analog)	Stereo audio cable with adapter 3.5 mm jack socket to 2 RCA plugs (to be ordered separately)	15

i You can purchase accessories and adapters from your local Sennheiser partner.

A

Connection option A: Optical (digital)

To achieve the best possible listening experience, we recommend that you connect your RS 195 headphone system to your home cinema or hi-fi system using the supplied optical digital cable.

Your wireless headphone system allows digital audio streaming using only PCM audio output from devices connected through the optical digital input **DIGITAL OPTICAL IN**. Refer to the sound menu or the instruction manual of your device to change from another audio stream (e.g. Bitstream) to PCM.

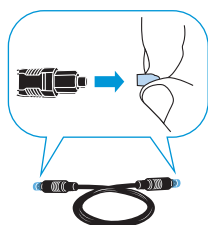
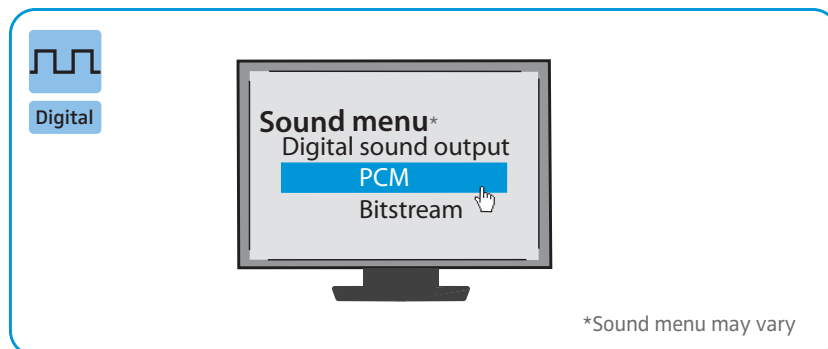

- ▶ Switch your audio source off before connecting the transmitter.
- ▶ Pull off the clear protective caps from both plugs before connecting the cable.
- ▶ Connect one end of the optical digital cable to the **DIGITAL OPTICAL IN** input of the transmitter and the other end to the optical output of your audio source.

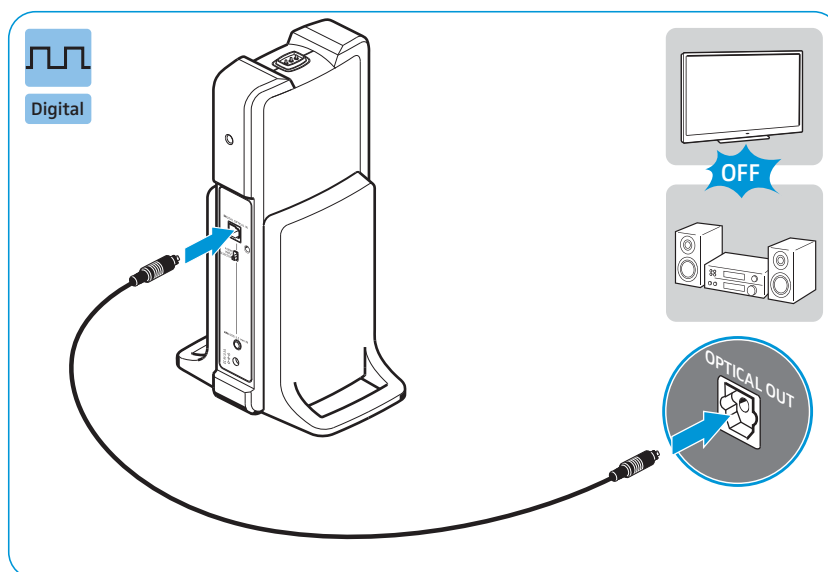

B

Connection option B: 3.5 mm or 6.3 mm/1/4" jack socket (analog)

Some TV models mute the loudspeakers when you connect the transmitter to the headphone socket. Check in the menu of your TV to see if the muting function can be deactivated. Alternatively, connect the TV and the transmitter using a different option (A or C).

- ▶ Switch your audio source off before connecting the transmitter.
- ▶ If necessary, connect the adapter 6.3 mm/1/4" jack plug onto the stereo audio cable.
- ▶ Connect the stereo audio cable to the 3.5 mm jack socket of the transmitter and to the headphone socket of your audio source.

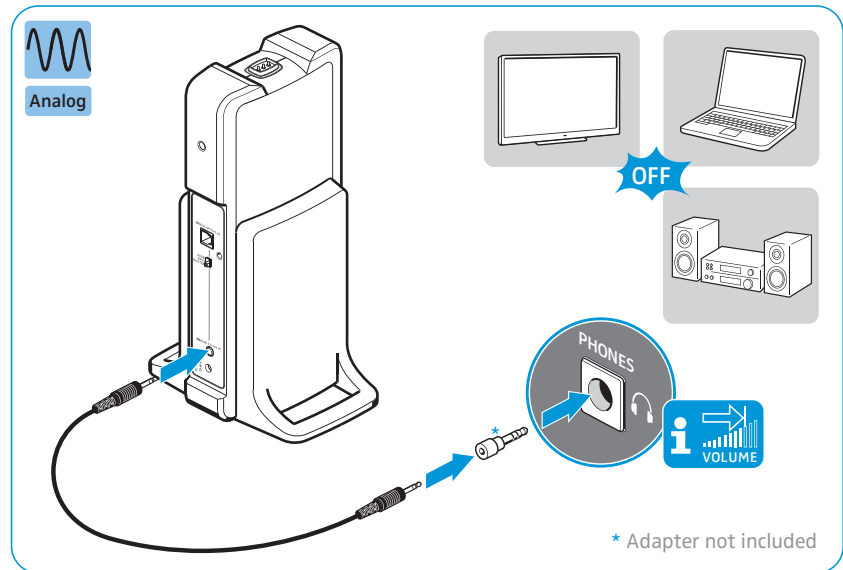

i Adjust the volume of the headphone socket on your audio source to at least about the medium level.

C

Connection option C: RCA (analog)

- ▶ Switch your audio source off before connecting the transmitter.
- ▶ Plug the RCA adapter onto the stereo audio cable.
- ▶ Connect the stereo audio cable to the 3.5 mm jack socket of the transmitter.
- ▶ Connect the RCA plugs to the RCA outputs of your audio source (in most cases "AUDIO OUT"). Connect the red RCA plug to the red RCA socket and the white RCA plug to the white or black RCA socket.

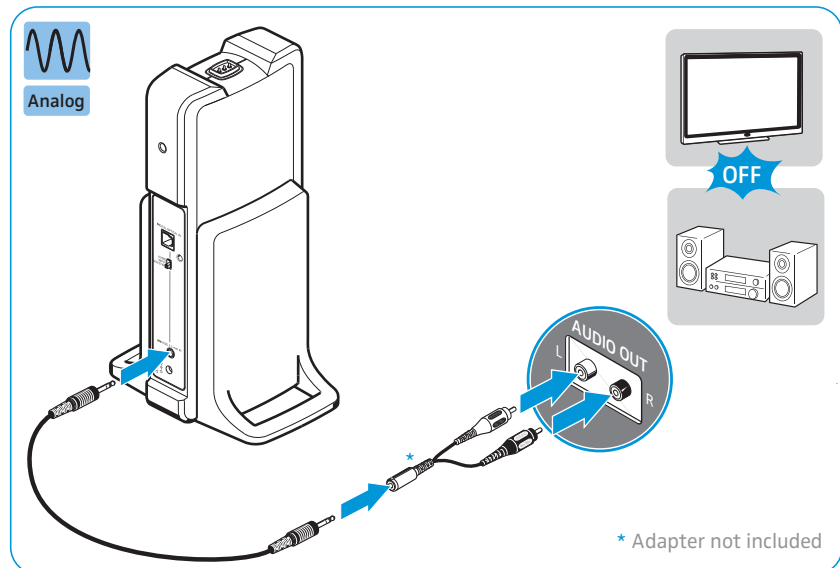

Connecting the transmitter to an AC wall outlet

- 1 Select a suitable country adapter and slide it onto the power supply unit until it locks firmly in place.
- 2 Connect the power supply unit connector to the power input socket of the transmitter.
- 3 Plug the power supply unit into an AC wall outlet.
The TR status LED  lights up for a second. The transmitter is in standby mode.

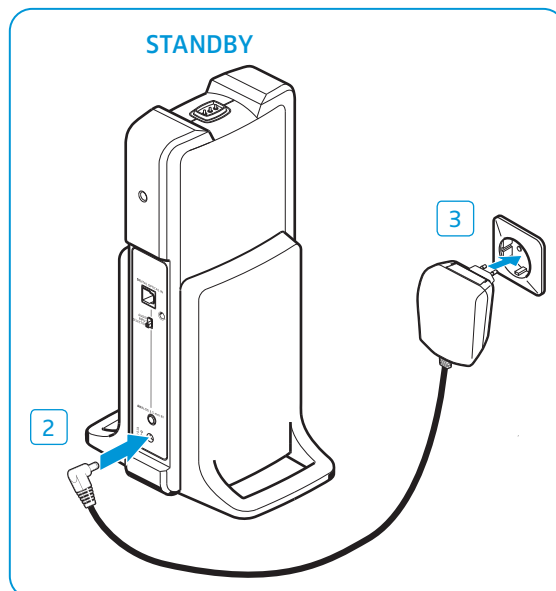
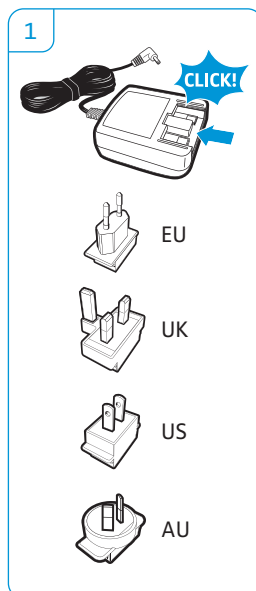

Inserting or replacing the rechargeable batteries

- 1 Lightly twist the ear pads counterclockwise until you overcome a slight resistance.
- 2 Lift the ear pads off the ear cups to reveal the battery compartments.
- 3 Insert the rechargeable batteries into the compartments. To replace the batteries, pull the batteries out of the compartments and insert the new ones. Be sure to observe correct polarity when inserting the batteries. Dispose of old batteries as special waste or return them to your specialist dealer.
- 4 Hook the ear pads onto the ear cups. As you put back the ear pads, observe the **L** (left) and **R** (right) markings on the rear of the ear pads.
- 5 Twist the ear pads clockwise until you hear a click sound. Ensure that they are locked firmly onto the ear cups.

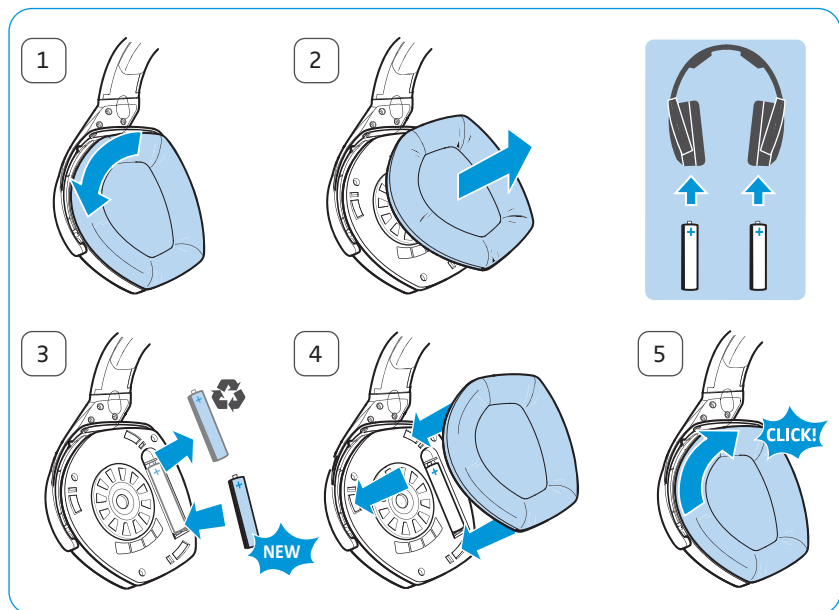

i You can also power the headphones using standard batteries (AAA size, 1.5 V). Note however, that standard batteries are not rechargeable, and if you are using non-rechargeable batteries, you must not place the headphones on the headphones holder.

Charging the rechargeable batteries

CAUTION Danger of damage to the headphones!



If you insert non-rechargeable batteries into the battery compartments, the batteries may leak during charging and can damage your headphones.

- ▶ Do not place the headphones on the headphones holder if you are using non-rechargeable batteries.



In general, a complete charging cycle takes about 8.5 hours. However, before using the headphones for the first time, charge the rechargeable batteries for at least 16 hours without interruption to optimize the performance of the batteries.

When the rechargeable batteries are almost empty, the HDR status LED turns red and you hear beeps in the headphones. The headphones switch off after a few minutes.

- ▶ Place the headphones on the headphones holder of the transmitter. You may place the headphones on either side provided that the charging contacts of the headphones and the transmitter connect. The headphones automatically switch off and the Charge status LED  on the transmitter lights up red. When the rechargeable batteries are fully charged, the Charge status LED  turns green.

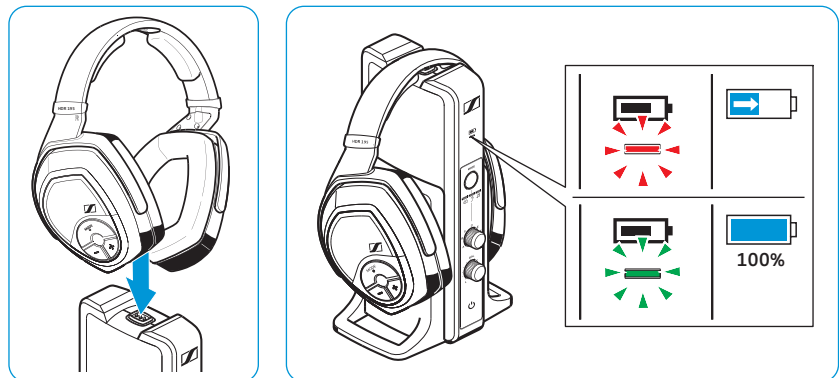

- i** When not in use, place the headphones on the headphones holder to ensure that batteries are fully charged when needed. The transmitter utilizes an intelligent battery charging technology that prevents overcharging.

After taking the headphones from the holder of the transmitter, the charge status LED indicates the approximate operating time of the headphones (see page 9).

Adjusting the headband

For good sound quality and best possible wearing comfort, the headband has to be adjusted to properly fit your head. The headphones feature an adjustable headband with a snap-in locking mechanism for easy adjustment.

- ▶ Wear the headphones so that the headband runs over the top of your head. Observe the **L** (left) and **R** (right) markings on the outer headband when putting the headphones on.
- ▶ Adjust the length of the headband until
 - your ears are comfortably covered by the ear pads,
 - you feel even, gentle pressure around your ears,
 - a snug fit of the headband on the head is ensured.

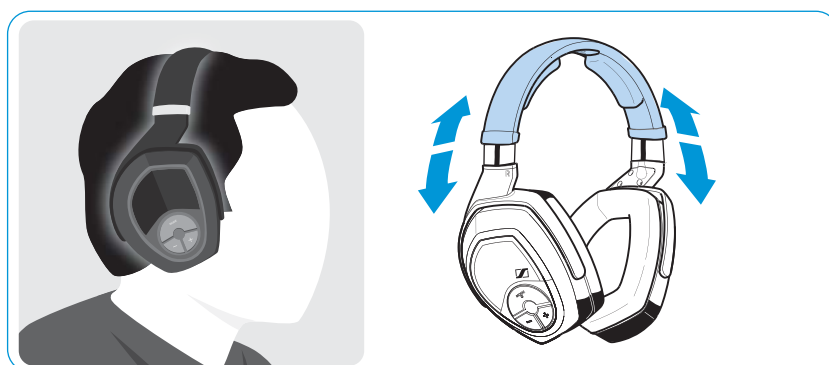

Using your RS 195 headphone system

Switching your wireless headphone system on



WARNING

Danger due to high volume levels!

Listening at high volume levels can lead to permanent hearing defects.

- ▶ Before putting the headphones on and before toggling between your audio inputs, adjust the volume on the headphones to a low level. Toggling between different inputs may cause an enormous volume jumps that can damage your hearing.
- ▶ Do not expose yourself to high volume levels for long periods of time.



- 1 Switch your audio source on.

If you are using the headphone socket (see page 14) to connect to your audio source, adjust the volume of the headphone socket on your audio source (e.g. TV) to at least the medium level.

- 2 Push the **AUDIO INPUT SELECTION** switch up or down to select your audio source (see page 21).

The status LED  on the transmitter lights up green.

- 3 Press and hold the HDR power button  for approx. 2 seconds to switch the headphones on.

The transmitter in standby mode recognizes the active paired headphones and automatically transmits a signal. The status LEDs on the transmitter and the headphones light up green.

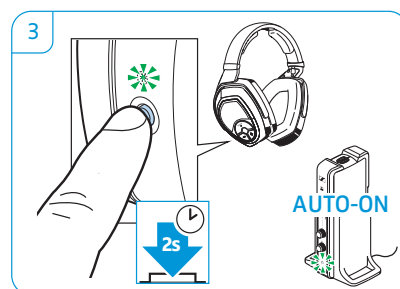
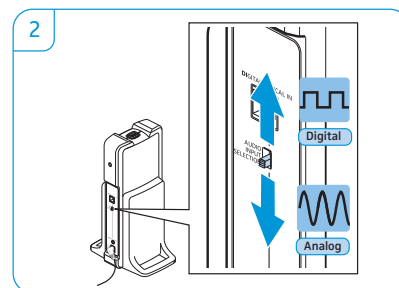
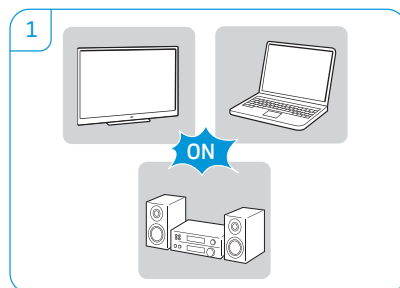

If the headphones are brought outside the transmission range or if there is no audio signal received from the transmitter for more than 5 minutes, the headphones switch off automatically.

Selecting an audio input

If both analog and digital audio inputs are connected to different audio sources, the headphone system enables you to toggle between the two inputs.

- ▶ Push the **AUDIO INPUT SELECTION** switch up to listen to an audio source connected to the digital optical input (see page 13).
- ▶ Push the **AUDIO INPUT SELECTION** switch down to listen to an audio source connected to the analog input (see page 14 and 15).

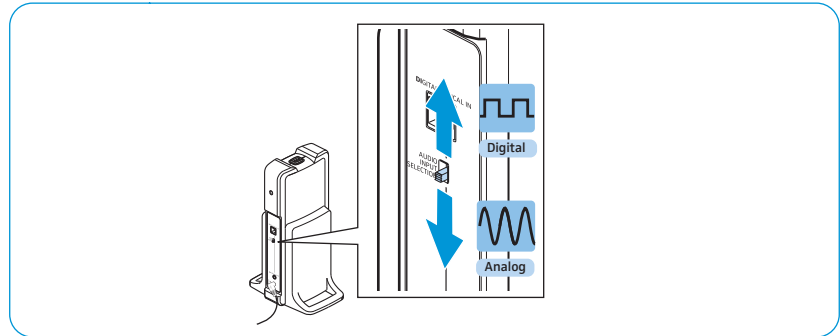

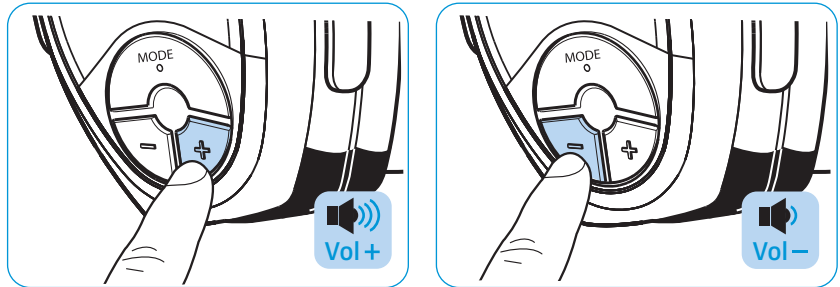

Adjusting the volume

- ▶ Press the Volume + button or the Volume – button repeatedly until the volume is adjusted to the desired level. When the minimum or maximum volume setting is reached, you hear a beep in the headphones.



Muting/unmuting the headphones

- ▶ Press the HDR power button  to mute the headphones.
- ▶ Press the HDR power button  or any of the volume +/- buttons to cancel the muting.

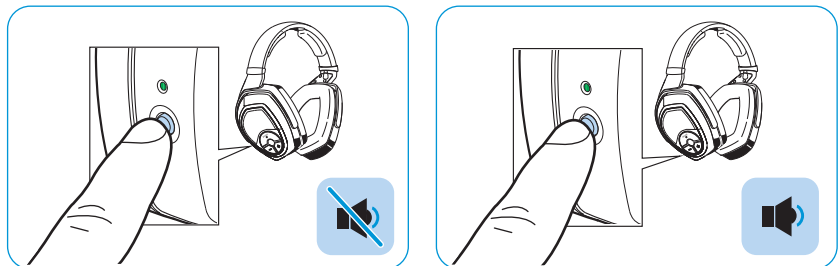

i If the headphones are muted for 15 minutes, the headphones switch off automatically to save energy.

Adjusting the balance

The balance control (**BAL**) allows for left/right volume adjustment. Adjust the balance so that you hear equally well with both ears.

- ▶ Turn the **BAL** control on the transmitter to the right (**R**) or to the left (**L**) to increase or reduce the volume for your right or left ear.

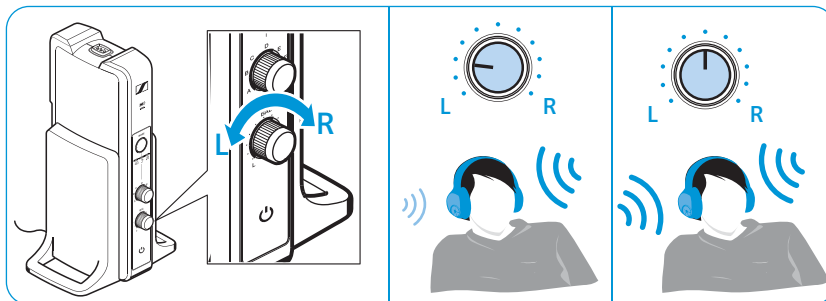

To reset the balance setting:

- ▶ Turn the **BAL** control to the middle position so that its position marker points vertically upwards.

Activating/deactivating “personal hearing”

You can use your RS 195 in two different ways:

- as a hearing-enhancing headphone system (“personal hearing”)
- as a conventional headphone system (“normal hearing”)

With “personal hearing” activated, you can use the headphone system to enhance your hearing. Different hearing profiles and additional sound optimization options offer you a tailored hearing experience – perfectly matching your personal preferences and hearing ability and allowing you to not only improve speech intelligibility but also to enhance music enjoyment.

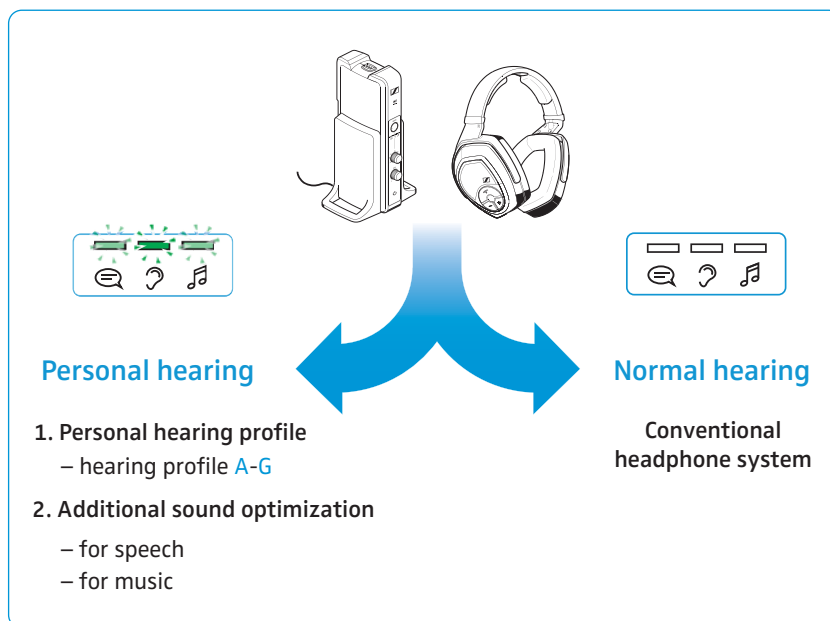

To activate/deactivate “personal hearing”:

- ▶ Press the **MODE** button on the transmitter or on the headphones for 2 seconds.

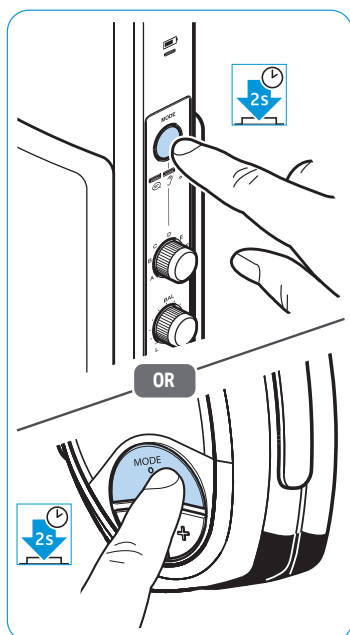

Personal hearing	Display	Meaning
activated		One of the hearing profiles A-G for hearing enhancement is selected (see next chapter). It might also be that one of the LEDs indicating sound optimization for speech or music listening lights up (see page 25).
deactivated		No LED lights up; “normal hearing” is activated

“Personal hearing” – Selecting a hearing profile for hearing enhancement

To select the personal hearing profile that best suits you, proceed as follows:

- 1 Switch on your audio source and select a program where speech is foregrounded. This will facilitate the accurate adjustment of the hearing profile.

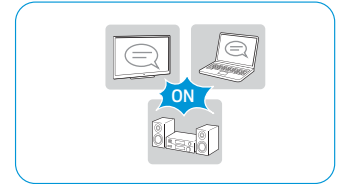

- 2 Use the **BAL** control to adjust the balance (see page 22). This ensures that each subsequently selected hearing profile is perfectly matched to your left/right balance setting.

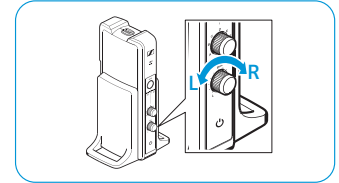

- 3 Press the **MODE** button on the transmitter or on the headphones for 2 seconds to activate “personal hearing” (see previous chapter).

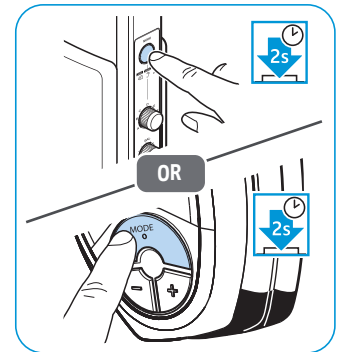

- 4 Press the **MODE** button on the transmitter or on the headphones repeatedly until only the LED  lights up.

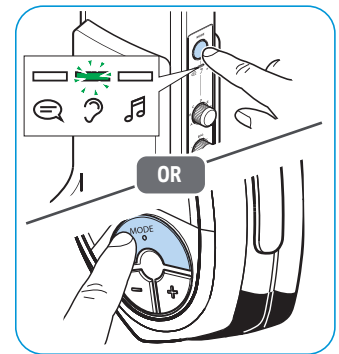

- 5 Use the rotary switch to select a hearing profile **A-G** and test which of the hearing profiles gives you the best sound quality and helps you to hear best.

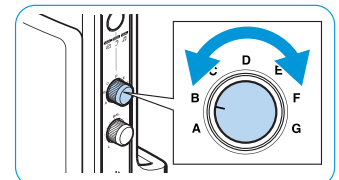

Your personal hearing profile is adjusted.



 We recommend that you repeat the selection of your personal hearing profile from time to time.

“Personal hearing” – Selecting additional sound optimization options for speech or music listening

Besides the hearing profiles **A-G**, you can select additional sound optimization options for speech or music listening.

- ▶ Press the **MODE** button on the transmitter or on the headphones repeatedly until the additional sound optimization option is activated.

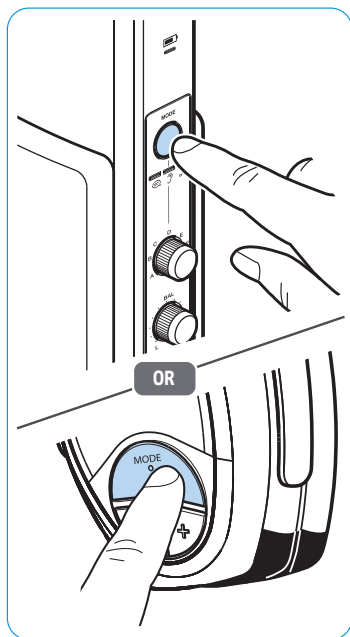

Additional sound optimization	Display	Meaning
none		One of the hearing profiles A-G for hearing enhancement is selected.
for speech reproduction		In addition to the selected hearing profile, speech intelligibility is improved as annoying noise is reduced.
for music reproduction		The dynamic range of the hearing profile is increased to preserve the sound image in the best possible way.

Pairing headphones to the transmitter

The headphones and the transmitter enclosed in this package have been paired from the factory. The following procedure is only necessary if you have cleared all pair settings from your wireless headphone system and you want to revive the lost pairing, or if you want to pair another set of headphones to the transmitter.

You can connect up to 2 paired headphones simultaneously with your TR 195 transmitter. If more than one pair of HDR 195 headphones are connected to the transmitter, you cannot make use of the personal hearing profiles in order to improve the listening situation. The hearing profiles can only be used with one pair of HDR 195 headphones.

- ▶ Place the headphones on the headphones holder of the transmitter for a second.

The Charge status LED  on the transmitter lights up red. The headphones are paired to the transmitter.

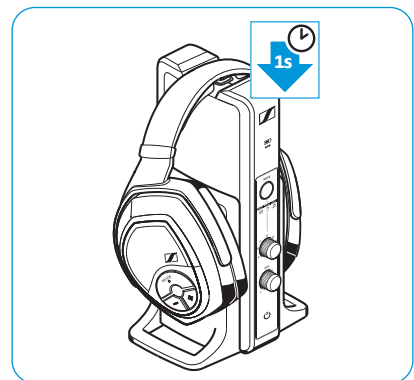

Switching your wireless headphones off

There are two ways to switch your wireless headphones off:

- A** ▶ Press and hold the HDR power button  for approx. 2 seconds. The headphones switch off. If no other pair of active wireless headphones is connected to the transmitter, the transmitter switches to standby mode. All LEDs are off.

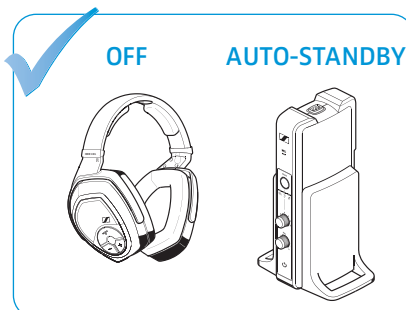
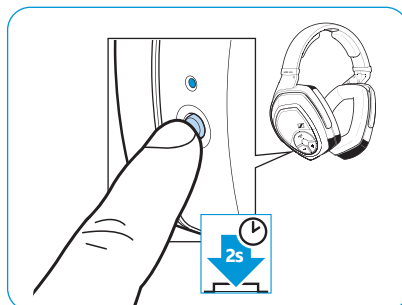

- B** ▶ Place the headphones on the headphones holder of the transmitter. The headphones switch off and the charging process starts (see page 18). If no other pair of active wireless headphones is connected to the transmitter, the transmitter switches to standby mode.

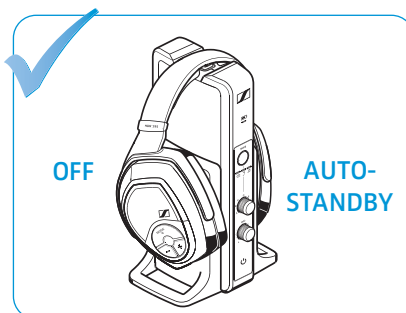
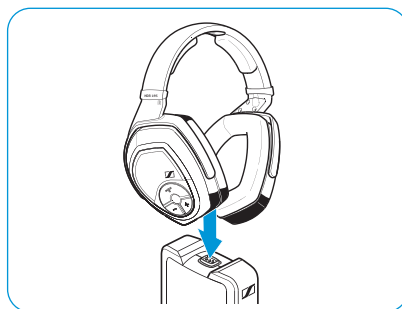

- i** To disconnect the transmitter from the power source, unplug the power supply unit from the AC wall outlet.

Cleaning and maintaining the RS 195

CAUTION

Liquids can damage the electronics of the product!

Liquids entering the housing of the product can cause a short-circuit and damage the electronics.

- ▶ Keep all liquids far away from the product.
- ▶ Do not use any cleansing agents or solvents.

To clean the wireless headphone system:

- ▶ Switch your wireless headphone system off and disconnect the transmitter from the AC wall outlet before cleaning.
- ▶ Clean the product only with a soft, dry cloth.

Replacing the ear pads

For reasons of hygiene, you should replace the ear pads from time to time. Spare ear pads are available at your local Sennheiser partner.

- 1 Lightly twist the ear pads counterclockwise until you overcome a slight resistance.
- 2 Lift the ear pads off the ear cups and dispose of them properly.
- 3 Hook the new ear pads onto the ear cups. Observe the **L** (left) and **R** (right) markings on the rear of the ear pads.
- 4 Twist the ear pads clockwise until you hear a click sound. Ensure that they are lock firmly onto the ear cups.

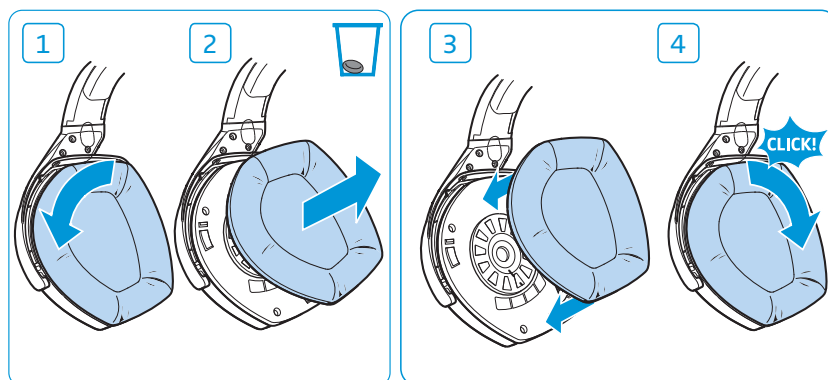

Troubleshooting

Sound problems

Problem	Possible cause	Possible solutions	Page
No sound	Headphones are switched off.	Switch the headphones on.	20
	No power connection.	Check the connection of the power supply unit.	16
	Headphones are muted.	Deactivate the muting function.	21
	Audio plug is not properly connected.	Check the audio plug connection.	12
	Audio source is switched off.	Switch the audio source on.	–
	Volume of the analog audio source is either set to the minimum or is on mute.	Increase the volume on the audio source to at least a medium level/Deactivate the muting function from the audio source.	–
	Audio cable is defective.	Replace the audio cable.	–
	Headphones are not correctly paired with the transmitter (e.g. additional headphones).	Pair the headphones with the transmitter again.	26
	Wrong audio input is selected.	Select the other audio input.	21
	Digital audio connection uses incompatible data transmission settings.	Set the digital audio output of your device/audio source to "PCM", with a sampling rate of max. 96 kHz (see the instruction manual of your audio source).	–
Sound dropouts/ no sound	Headphones are out of the transmitter's range.	Reduce the distance between headphones and transmitter.	–
	Signal is shielded.	Remove obstacles between the transmitter and headphones.	–
	There are interfering devices (e.g. WLAN routers, Bluetooth devices or microwaves) in the vicinity.	Change the position of the transmitter or of the headphones. Ensure that the transmitter is separated from other wireless devices by at least 50 cm/20".	11 –
Sound is too low	Headphone volume is adjusted too low.	Increase the volume on the headphones.	21
	Volume of the analog audio source is adjusted too low.	Increase the volume on the analog audio source to at least a medium level.	–
Hear echoes and TV tone when using headphones	Some TVs can adjust a delay or latency of the audio signal for the digital audio output.	Check the audio output settings of your TV and set the latency to "0".	–
Sound only on one ear	Balance is misadjusted.	Adjust the balance.	22
	Audio cable is not properly connected.	Check the plug connection.	12
	Audio cable is defective.	Replace the audio cable.	–

Problem	Possible cause	Possible solutions	Page
Sound is distorted	Signal of the audio source is distorted.	Reduce the volume of the audio source.	–
	Headphone volume is adjusted too high.	Reduce the volume on the headphones.	21
	Volume of the analog audio source is adjusted too high.	Decrease the volume of the analog audio source at least to a medium volume level.	–
Hearing profiles cannot be activated. The LEDs for personal hearing are flashing	More than one pair of headphones is connected to the transmitter.	Switch off all other connected headphones. The hearing profiles can only be used with one pair of HDR 195 headphones.	–

Other problems

Problem	Possible cause	Possible solutions	Page
Transmitter does not turn on	No power connection.	Check the connection of the power supply unit.	16
Headphones do not turn on	The rechargeable batteries are almost empty.	Recharge the rechargeable batteries.	18
	No batteries inside the battery compartments.	Insert the rechargeable batteries.	17
	The rechargeable batteries are inserted the wrong way round.	Remove the rechargeable batteries from the headphones and reinsert them again. Observe correct polarity.	17
Operating time decreases	The rechargeable batteries are exhausted.	Replace the rechargeable batteries with new ones.	17
Hearing profile cannot be activated	More than one pair of headphones is connected to the transmitter (pressing the MODE button makes the 3 LEDs for sound optimization flash 3 times).	Switch off all other connected headphones.	27
You hear beeps in the headphones	The rechargeable batteries are almost empty.	Recharge the rechargeable batteries.	18
Headphones cannot be connected to the transmitter	Distance to the transmitter is too large.	Reduce the distance to the transmitter.	–
	Headphones are not paired with the transmitter.	Pair the headphones with the transmitter.	26
	Another set of headphones is being charged so I can't pair my second headphones.	Perform a proximity pairing: 1. Place the headphones as close as possible to the transmitter. 2. Switch the headphones on. 3. Press the Volume +/- buttons simultaneously for about 7 seconds.	–
	Headphones are not compatible.	Use Sennheiser HDR 165, 175, 185, or 195 wireless headphones only.	–

If you encounter a problem that is not listed in the table, or if the solutions provided do not work, please visit the RS 195 product page at www.sennheiser.com for the most up-to-date list of frequently asked questions.

You may also contact your local Sennheiser service partner for assistance. To find a Sennheiser service partner in your country, visit www.sennheiser.com.

Leaving the range of the transmitter



The range of the transmitter largely depends on environmental conditions such as wall thickness, wall composition etc. If the headphones leave the range of the transmitter, the audio first cuts out occasionally until it finally cuts out completely.

If you re-enter the transmission range within 5 minutes, the connection is automatically re-established.

If you spend more than 5 minutes outside the transmission range, the headphones switch off automatically.

Clearing the pair settings on the headphones

- 1 Press the Volume +/- buttons simultaneously and hold for 2 seconds. The HDR status LED blinks red rapidly.
- 2 Press the HDR power button  while continuously holding the Volume +/- buttons. Release all the 3 buttons. The HDR status LED lights up green or red, depending on the battery condition, and starts blinking slowly. The pair settings on the headphones are cleared.

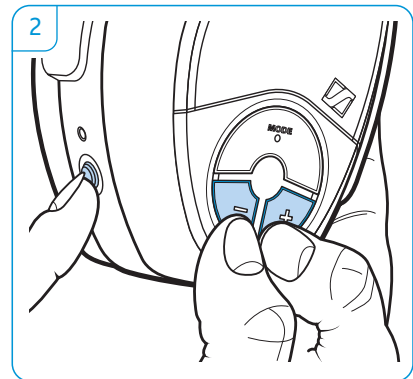
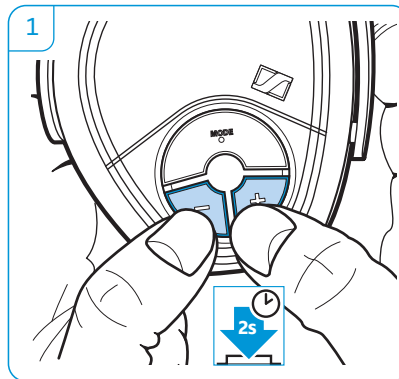

Specifications

RS 195 headphone system

Carrier frequency	2.40 to 2.48 GHz
Modulation	8-FSK Digital
SNR	Analog input: typ. 85 dBA at 1 V _{rms} Digital input: > 90 dBA
RF output power	max. 10 dBm Class 1
Transmission range	up to 100 m/328 ft line of sight
Max. number of simultaneously connected headphones	2
Temperature range	Operation: 0°C to +40°C/32°F to 104°F Storage: -25°C to +70°C/-13°F to 158°F
Relative humidity	Operation: 10 to 80%, non condensing Storage: 10 to 90%

HDR 195 headphones

Transducer principle	circumaural, closed
Transducer system	dynamic, neodymium magnets
Frequency response	17 Hz to 22 kHz
Max. SPL	max. 117 dB at 1 kHz, 3% THD
THD	< 0.5% at 1 kHz, 100 dB SPL
Operating time	up to 18 hours
Charging time of rechargeable batteries	up to 8 hours 30 min
Power supply	2 AAA size low self-discharge NiMH rechargeable batteries, 1.2 V, 820 mAh
Weight (incl. batteries)	approx. 340 g
Dimensions (W x H x D)	approx. 17 cm x 20 cm x 9.5 cm

TR 195 transmitter

Connections	Digital: optical Analog: 3.5 mm stereo jack socket
Power supply	9 V $\overline{\sim}$, 300 mA
Power consumption	Operation: typ. 4 W Standby mode: \leq 0.3 W (without charging)
Dimensions (W x H x D)	approx. 12.7 cm x 23.4 cm x 10.9 cm

Sennheiser NT 9-3AW power supply unit

Rated input	100 – 240 V $\overline{\sim}$, 50 – 60 Hz, 80 mA
Rated output	9 V $\overline{\sim}$, 300 mA
Temperature range	Operation: 0°C to +40°C/32°F to 104°F Storage: -25°C to +70°C/-13°F to 158°F
Relative humidity	Operation: 10 to 80%, non condensing Storage: 10 to 90%

Manufacturer declarations

Warranty

Sennheiser electronic GmbH & Co. KG gives a warranty of 24 months on this product.

For the current warranty conditions, please visit our website at www.sennheiser.com or contact your Sennheiser partner.

FOR AUSTRALIA ONLY

Sennheiser goods come with guarantees that cannot be excluded under the Australian Consumer Law. You are entitled to a replacement or refund for a major failure and compensation for any other reasonably foreseeable loss or damage. You are also entitled to have the goods repaired or replaced if the goods fail to be of acceptable quality and the failure does not amount to a major failure.

This warranty is in addition to other rights or remedies under law. Nothing in this warranty excludes, limits or modifies any liability of Sennheiser which is imposed by law, or limits or modifies any remedy available to the consumer which is granted by law.

To make a claim under this warranty, contact Sennheiser Australia Pty Ltd, Unit 3, 31 Gibbes Street Chatswood NSW 2067, Australia; Phone: (02) 9910 6700, email: service@sennheiser.com.au

All expenses of claiming the warranty will be borne by the person making the claim.

The Sennheiser International Warranty is provided by Sennheiser Australia Pty Ltd (ABN 68 165 388 312), Unit 3, 31 Gibbes Street Chatswood NSW 2067, Australia.

In compliance with the following requirements

- WEEE Directive (2012/19/EU)



Please dispose of this product at the end of its operational lifetime by taking it to your local collection point or recycling center for such equipment.

- Battery Directive (2013/56/EU)



The supplied standard/rechargeable batteries can be recycled. Please dispose of them as special waste or return them to your specialist dealer. In order to protect the environment, only dispose of exhausted batteries.

CE Declaration of Conformity

- R&TTE Directive (1999/5/EC)
- EMC Directive (2014/30/EU)
- Low Voltage Directive (2014/35/EU)
- ErP Directive (2009/125/EC)
- RoHS Directive (2011/65/EU)

The CE Declaration of Conformity is available on our website at www.sennheiser.com.

Statements regarding FCC and Industry Canada

FCC Declaration of Conformity (DoC)	
	SENNHEISER Model No: RS 195
We,	Sennheiser Electronic Corporation One Enterprise Drive • Old Lyme • CT 06371 • USA Tel: +1 (860) 434 9190 Fax: +1 (860) 434 1759
declare the above device comply with the requirements of Federal Communications Commission.	
This device complies with Part 15 of the FCC rules. Operation is subjected to the following two conditions:	
1) This device may not cause harmful interference, and	
2) This device must accept any interference received, including interference that may cause undesired operation.	
Responsible Party: Greg Beebe	

This device complies with Part 15 of the FCC Rules and with RSS-210 of Industry Canada. Operation is subject to the following two conditions: (1) this device may not cause harmful interference, and (2) this device must accept any interference received, including interference that may cause undesired operation.

This equipment has been tested and found to comply with the limits for a Class B digital device, pursuant to Part 15 of the FCC Rules. These limits are designed to provide reasonable protection against harmful interference in a residential installation. This equipment generates, uses and can radiate radio frequency energy and, if not installed and used in accordance with the instructions, may cause harmful interference to radio communications. However, there is no guarantee that interference will not occur in a particular installation. If this equipment does cause harmful interference to radio or television reception, which can be determined by turning the equipment off and on, the user is encouraged to try to correct the interference by one or more of the following measures:

- Reorient or relocate the receiving antenna.
- Increase the separation between the equipment and receiver.
- Connect the equipment into an outlet on a circuit different from that to which the receiver is connected.
- Consult the dealer or an experienced radio/TV technician for help.

CAN ICES-3 (B)/NMB-3(B)

RF Radiation Exposure Information

Since the radiated output power of this device is far below the FCC radio frequency exposure limits, it is not subjected to routine RF exposure evaluation as per Section 2.1093 of the FCC rules.

Trademarks

Sennheiser is a registered trademark of Sennheiser electronic GmbH & Co. KG. Other product and company names mentioned in this instruction manual may be the trademarks or registered trademarks of their respective holders.



Sennheiser electronic GmbH & Co. KG

Am Labor 1, 30900 Wedemark, Germany
www.sennheiser.com

Publ. 01/15, A01